

FREE SPACE REQUIRED FOR MAINTENANCE

FREE SPACE REQUIRED FOR INSTALLATION

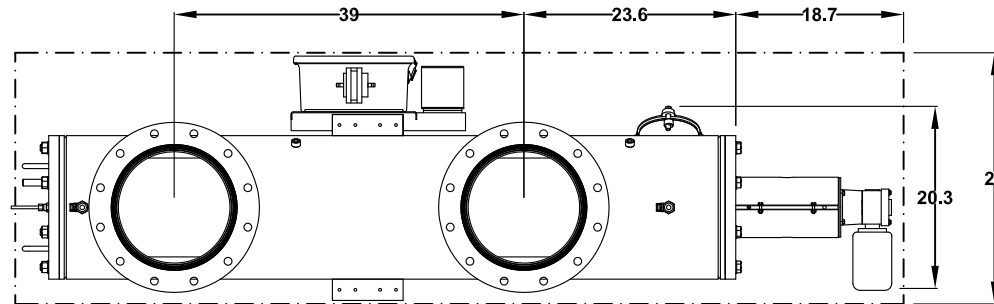
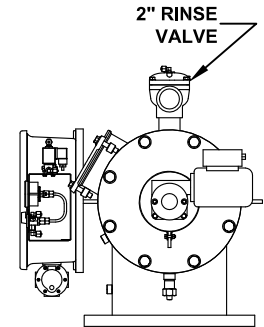
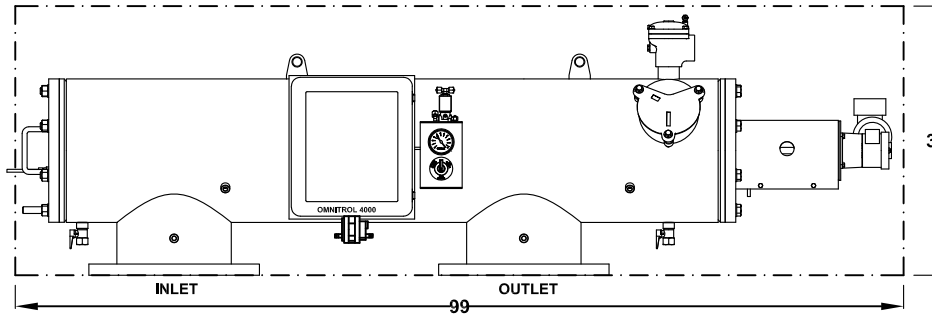
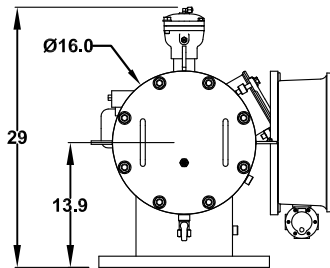
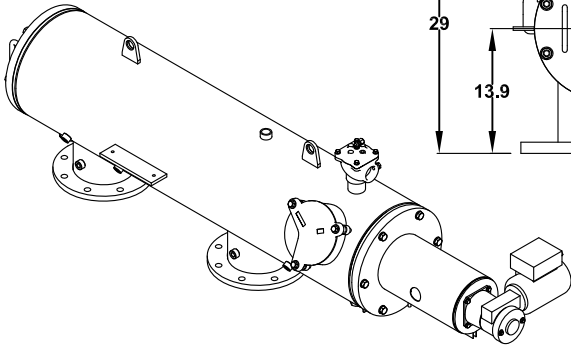

TECHNICAL DATA

MAXIMUM FLOW RATE:	2640 G.P.M.
AVAILABLE SCREEN SIZES:	10, 25, 50, 80, 100, 150, 200, 400, 800, 1000, 1500 MICRON
OPEN SCREEN AREA:	1240 SQ. INCHES
MAXIMUM WORKING PRESSURE:	150 PSIG
MINIMUM INLET PRESSURE REQUIRED DURING RINSE CYCLE	30 PSIG
MAX. WORKING TEMPERATURE:	150°F
INLET/OUTLET FLANGES:	12" ANSI 150#
DRAIN VALVE CONNECTION:	2"
DRAIN HEADER SIZE:	2" MINIMUM
DRIVE MOTOR RATING:	1/4 or 1/3 HP, TEFC
INPUT VOLTAGES TO CONTROLLER:	110-120 Vac - 60 Hz - 1 Phase 220-240 Vac - 50 Hz - 1 Phase
APPROXIMATE WEIGHT - DRY:	730 LBS.
APPROXIMATE SHIPPING WEIGHT:	900 LBS.
APPROXIMATE WEIGHT FULL OF WATER:	1175 LBS.

ALL DIMENSIONS IN INCHES UNLESS INDICATED

Orival Inc. reserves the right to modify filter dimensions without prior notice.

DATA SHEET

ORE/A-12-PS

AUTOMATIC SELF-CLEANING FILTER

ORIVAL, INC.

213 S. VAN BRUNT ST.

ENGLEWOOD, N.J. 07631

TEL (201) 568-3311, FAX (201) 568-1916

www.orival.com

filters@orival.com