

FREE SPACE REQUIRED FOR MAINTENANCE

FREE SPACE REQUIRED FOR INSTALLATION

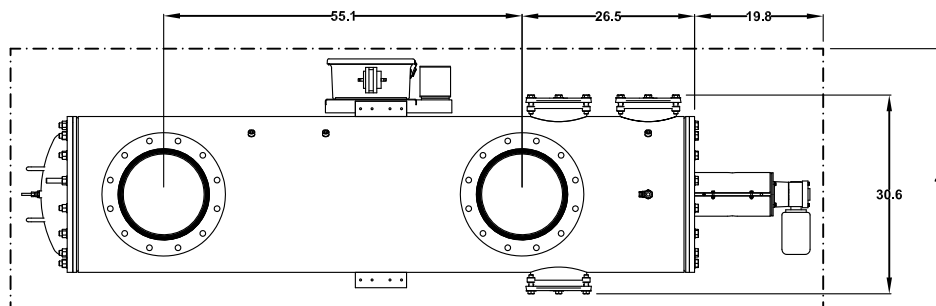
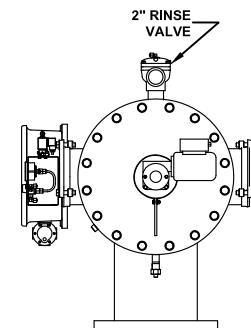
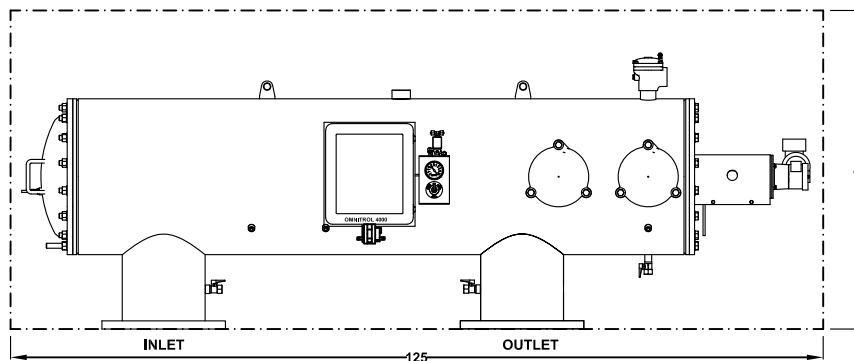
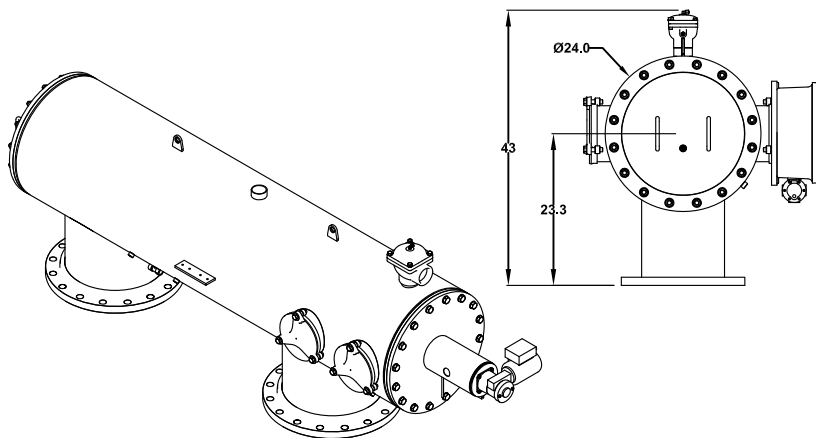

ALL DIMENSIONS IN INCHES UNLESS INDICATED

Orival Inc. reserves the right to modify filter dimensions without prior notice.

TECHNICAL DATA

MAXIMUM FLOW RATE:	3500 G.P.M.
AVAILABLE SCREEN SIZES:	10, 25, 50, 80, 100, 150, 200, 400, 800, 1000, 1500 MICRON
OPEN SCREEN AREA:	2500 SQ. INCHES
MAXIMUM WORKING PRESSURE:	150 PSIG
MINIMUM INLET PRESSURE REQUIRED DURING RINSE CYCLE	30 PSIG
MAX. WORKING TEMPERATURE:	150°F
INLET/OUTLET FLANGES:	12" ANSI 150#
DRAIN VALVE CONNECTION:	2"
DRAIN HEADER SIZE:	2" MINIMUM
DRIVE MOTOR RATING:	1/4 or 1/3 HP, TEFC
INPUT VOLTAGES TO CONTROLLER:	110-120 Vac - 60 Hz - 1 Phase 220-240 Vac - 50 Hz - 1 Phase
APPROXIMATE WEIGHT - DRY:	1360 LBS.
APPROXIMATE SHIPPING WEIGHT:	1495 LBS.
APPROXIMATE WEIGHT FULL OF WATER:	2760 LBS.

DATA SHEET

ORE/A-12-PX

AUTOMATIC SELF-CLEANING FILTER

ORIVAL, INC.

213 S. VAN BRUNT ST.

ENGLEWOOD, N.J. 07631

TEL (201) 568-3311, FAX (201) 568-1916

www.orival.com
filters@orival.com