

FREE SPACE REQUIRED
FOR MAINTENANCE

FREE SPACE REQUIRED
FOR INSTALLATION

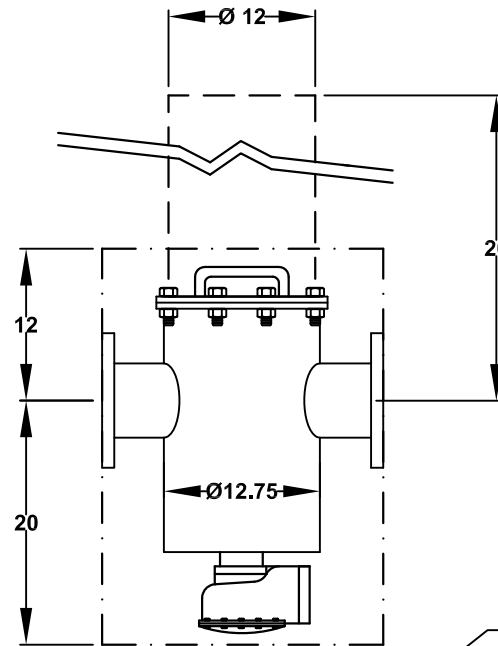

TOP VIEW WITH Ø 14
COVER REMOVED

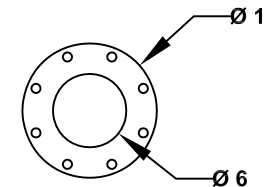
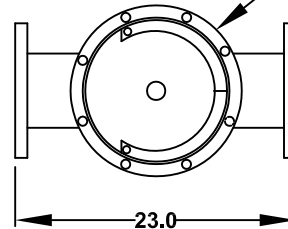
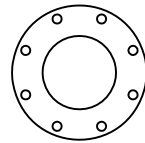

ALL DIMENSIONS IN INCHES UNLESS INDICATED

Orival Inc. reserves the right to modify filter dimensions without prior notice.

TECHNICAL DATA

MAXIMUM FLOW RATE:	900 G.P.M.
AVAILABLE SCREEN SIZES:	3000, 5000 & 8000 MICRON
MAXIMUM WORKING PRESSURE:	150 PSIG
INLET/OUTLET FLANGES:	6" ANSI 150#
DRAIN VALVE CONNECTION:	3"
DRY / SHIPPING WEIGHT:	240 / 320 POUNDS

ORC-06

AUTOMATIC SELF-CLEANING FILTER

ORIVAL, INC.
213 S. VAN BRUNT ST.
ENGLEWOOD, N.J. 07631
TEL (201) 568-3311, FAX (201) 568-1916
www.orival.com -- filters@orival.com