

FREE SPACE REQUIRED FOR MAINTENANCE

FREE SPACE REQUIRED FOR INSTALLATION

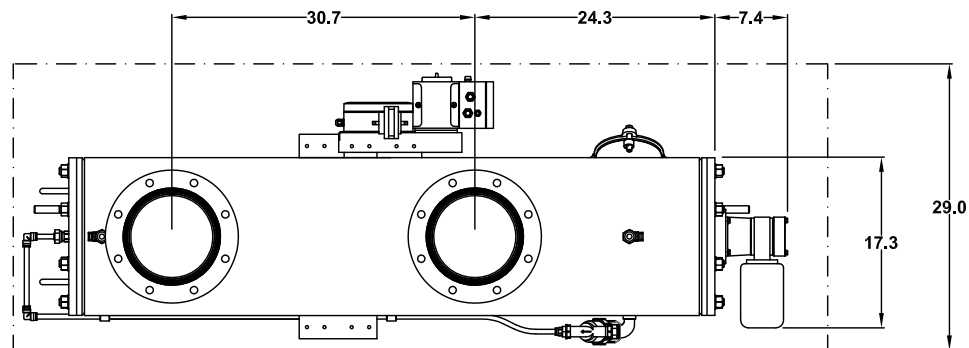
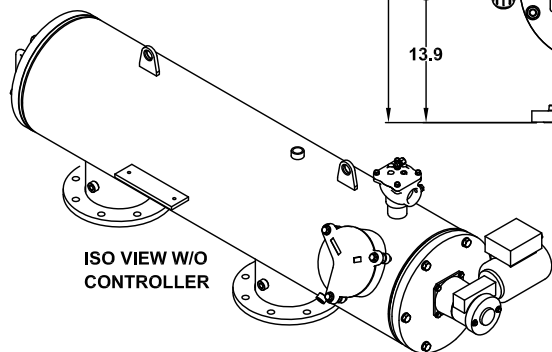
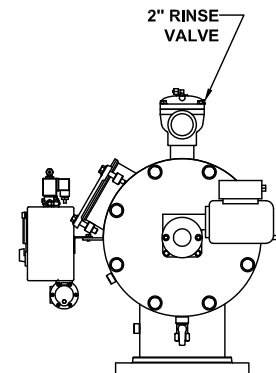
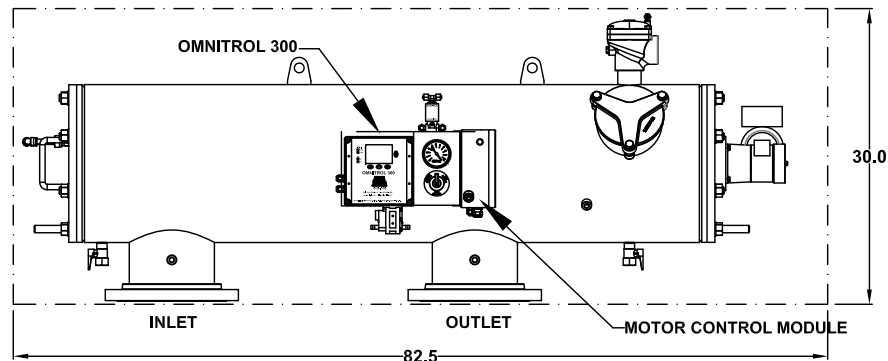
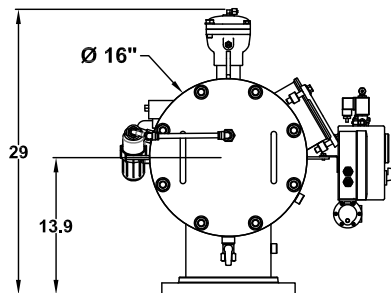

TECHNICAL DATA

MAXIMUM FLOW RATE:	1320 G.P.M.
AVAILABLE SCREEN MICRON SIZES:	5, 10, 15, 25, 30, 40, 50, 80, 100, 120, 150, 200, 300, 400, 800, 1000, 1500, 3000
OPEN SCREEN AREA:	930 SQ. INCHES
MAXIMUM WORKING PRESSURE:	150 PSIG
MINIMUM INLET PRESSURE REQUIRED DURING RINSE CYCLE	30 PSIG
MAX. WORKING TEMPERATURE:	150°F
INLET/OUTLET FLANGES:	8" ANSI B16.5 150# RF
DRAIN VALVE CONNECTION:	2"
DRAIN HEADER SIZE:	2" MINIMUM
DRIVE MOTOR RATING:	1/3 HP, TEFC
AVAILABLE INPUT VOLTAGES TO CONTROLLER and MOTOR:	110-120 Vac - 60 Hz - 1 Phase or 220-240 Vac - 50 Hz - 1 Phase
APPROXIMATE WEIGHT - DRY:	620 LBS.
APPROXIMATE SHIPPING WEIGHT:	760 LBS.
APPROXIMATE WEIGHT FULL OF WATER:	995 LBS.

ALL DIMENSIONS IN INCHES UNLESS INDICATED

Orival Inc. reserves the right to modify filter dimensions without prior notice.

DATA SHEET

ORE/B-08-PS

AUTOMATIC SELF-CLEANING FILTER

ORIVAL, INC.

213 S. VAN BRUNT ST.

ENGLEWOOD, N.J. 07631

TEL (201) 568-3311, FAX (201) 568-1916

www.orival.com

filters@orival.com