

FREE SPACE REQUIRED FOR MAINTENANCE

FREE SPACE REQUIRED FOR INSTALLATION

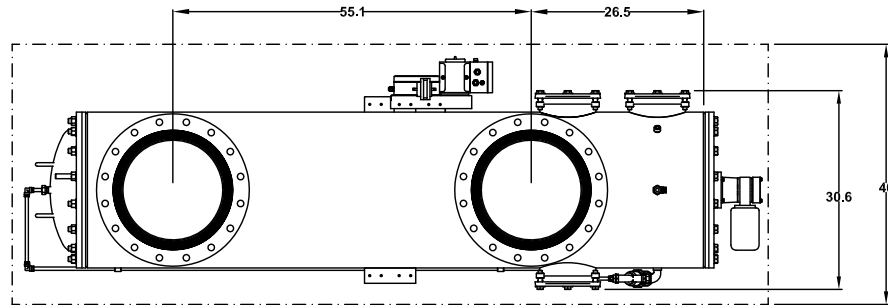
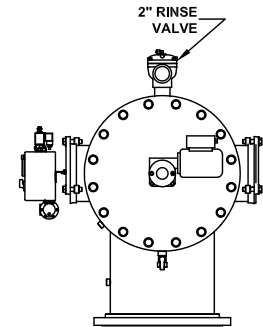
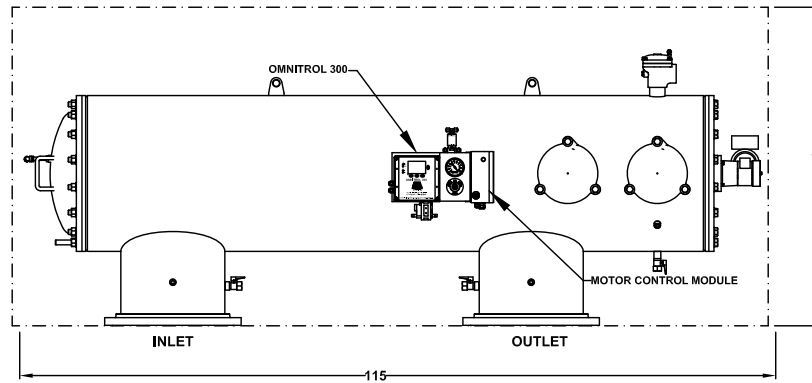
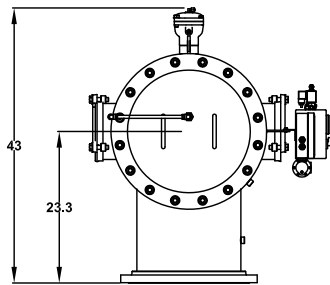
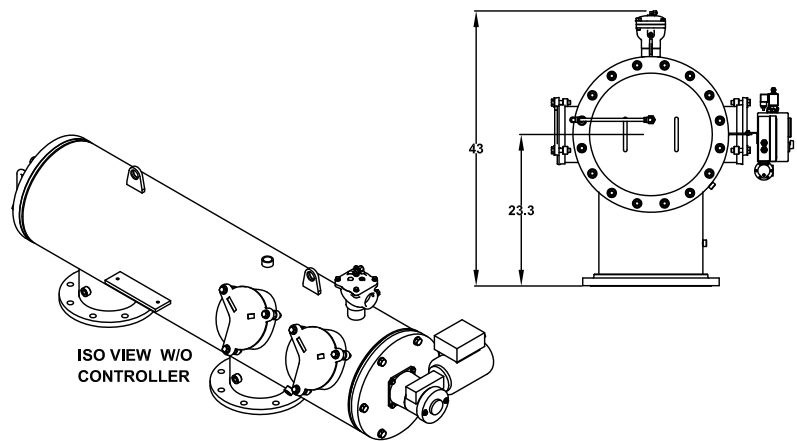

ALL DIMENSIONS IN INCHES UNLESS INDICATED
Orival Inc. reserves the right to modify filter dimensions without prior notice.

TECHNICAL DATA

MAXIMUM FLOW RATE:	6000 G.P.M.
AVAILABLE SCREEN MICRON SIZES:	5, 10, 15, 25, 30, 40, 50, 80, 100, 120, 150, 200, 300, 400, 800, 1000, 1500, 3000
OPEN SCREEN AREA:	2500 SQ. INCHES
MAXIMUM WORKING PRESSURE:	150 PSIG
MINIMUM INLET PRESSURE REQUIRED DURING RINSE CYCLE	30 PSIG
MAX. WORKING TEMPERATURE:	150°F
INLET/OUTLET FLANGES:	16" ANSI B16.5 150# RF
DRAIN VALVE CONNECTION:	2"
DRAIN HEADER SIZE:	2" MINIMUM
DRIVE MOTOR RATING:	1/3 HP, TEFC
AVAILABLE INPUT VOLTAGES TO CONTROLLER and MOTOR:	110-120 Vac - 60 Hz - 1 Phase 220-240 Vac - 50 Hz - 1 Phase
APPROXIMATE WEIGHT - DRY:	1420 LBS.
APPROXIMATE SHIPPING WEIGHT:	1555 LBS.
APPROXIMATE WEIGHT FULL OF WATER:	2820 LBS.

DATA SHEET

ORE/B-16-PX
AUTOMATIC SELF-CLEANING FILTER

ORIVAL, INC.
213 S. VAN BRUNT ST.
ENGLEWOOD, N.J. 07631
TEL (201) 568-3311, FAX (201) 568-1916
www.orival.com
filters@orival.com