

FREE SPACE REQUIRED FOR MAINTENANCE

FREE SPACE REQUIRED FOR INSTALLATION

ALL DIMENSIONS IN INCHES UNLESS INDICATED

Orival Inc. reserves the right to modify filter dimensions without prior notice.

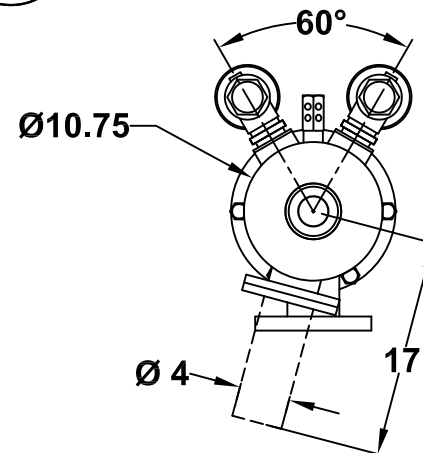
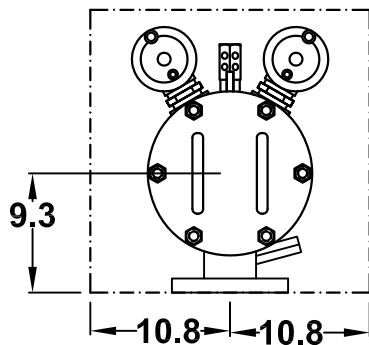

TECHNICAL DATA

MAXIMUM FLOW RATE:	350 G.P.M.
AVAILABLE SCREEN MICRON SIZES:	5, 10, 15, 25, 30, 40, 50, 80, 100, 120, 150, 200, 400, 800, 1000, 1500, 3000
OPEN AREA STANDARD SCREEN :	474 SQ. INCHES
OPEN AREA HIGH PERFORMANCE SINTERED MULTI-LAYERED SCREEN:	713 SQ. INCHES
MAXIMUM WORKING PRESSURE:	150 PSIG
MINIMUM INLET PRESSURE REQUIRED DURING RINSE CYCLE:	30 PSIG
MAX. WORKING TEMPERATURE:	150°F
INLET/OUTLET FLANGES:	4" ANSI 150#
DRAIN VALVE CONNECTION:	2 X 2" THREADED
DRAIN HEADER SIZE:	3" MINIMUM
APPROX. EMPTY WEIGHT:	280 LBS.
APPROX. FULL OF WATER WEIGHT:	460 LBS.

DATA SHEET

ORI-04-PE

AUTOMATIC SELF-CLEANING FILTER

REV 4/14

ORIVAL, INC.

213 S. VAN BRUNT ST.

ENGLEWOOD, N.J. 07631

TEL (201) 568-3311, FAX (201) 568-1916

www.orival.com, filters@orival.com