

FREE SPACE REQUIRED
FOR MAINTENANCE

FREE SPACE REQUIRED
FOR INSTALLATION

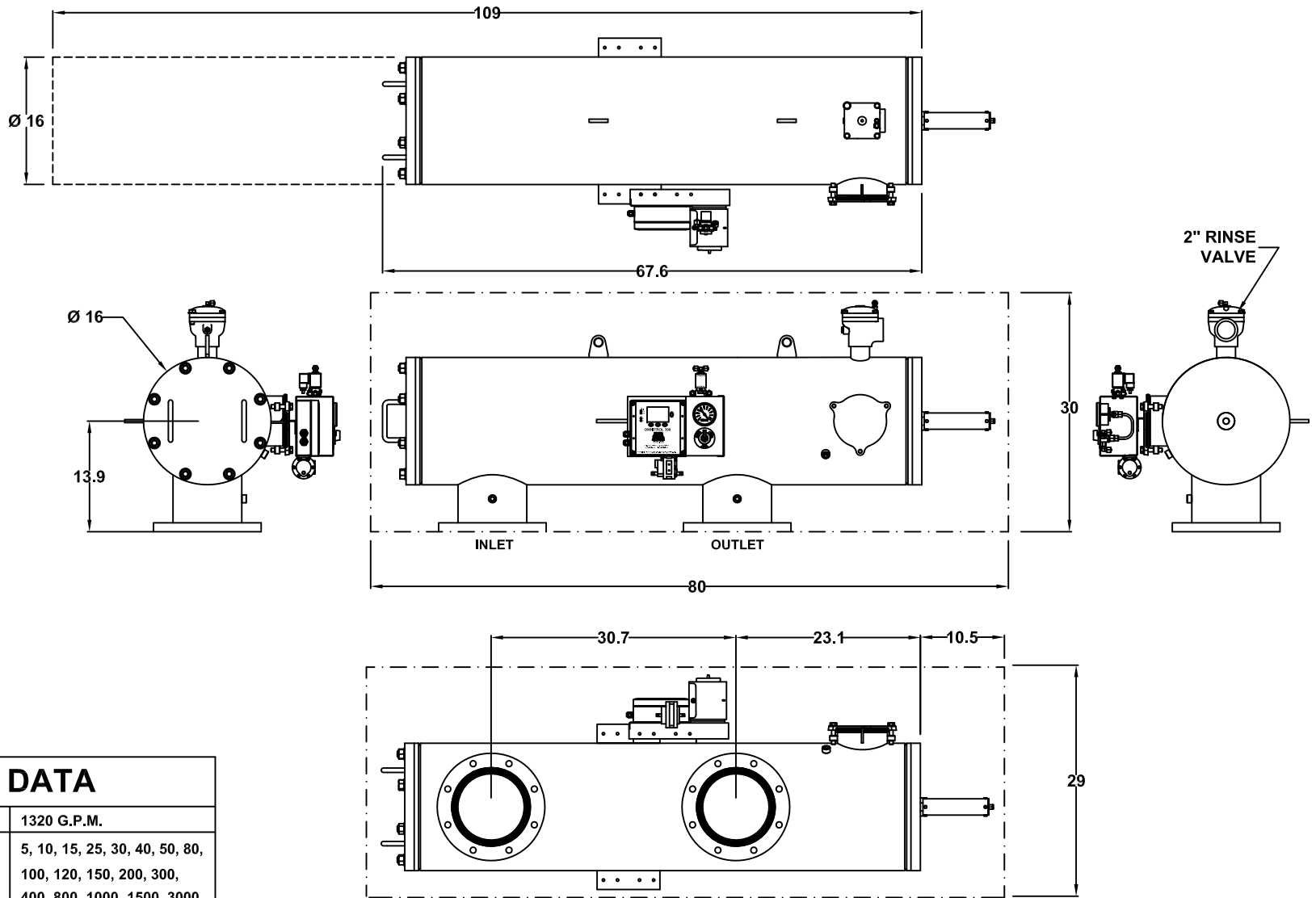

TECHNICAL DATA

MAXIMUM FLOW RATE:	1320 G.P.M.
AVAILABLE SCREEN MICRON SIZES:	5, 10, 15, 25, 30, 40, 50, 80, 100, 120, 150, 200, 300, 400, 800, 1000, 1500, 3000
OPEN SCREEN AREA STANDARD SCREEN:	614 SQ. INCHES
OPEN SCREEN AREA HIGH PERFORMANCE MULTI LAYERED SINTERED SCREEN:	930 SQ. INCHES
MAXIMUM WORKING PRESSURE:	150 PSIG
MINIMUM INLET PRESSURE REQUIRED DURING RINSE CYCLE	30 PSIG
MAX. WORKING TEMPERATURE:	150°F
INLET/OUTLET FLANGES:	8" ANSI 150# RF
DRAIN VALVE CONNECTION:	2"
DRAIN HEADER SIZE:	2" MINIMUM
APPROXIMATE WEIGHT - DRY:	620 LBS.
APPROXIMATE SHIPPING WEIGHT:	760 LBS.
APPROXIMATE WEIGHT FULL OF WATER:	995 LBS.

ALL DIMENSIONS IN INCHES UNLESS INDICATED
Orval Inc. reserves the right to modify filter dimensions without prior notice.

DATA SHEET
ORZ-08-PS
AUTOMATIC SELF-CLEANING FILTER

ORIVAL, INC.
213 S. VAN BRUNT ST.
ENGLEWOOD, N.J. 07631
TEL (201) 568-3311, FAX (201) 568-1916
www.orival.com
filters@orival.com